

# Switches & Switchgear

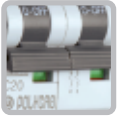



**Positive Contact Position Indication:**

Red and Green flag indication provided below the knob gives indication of positive electrical ON/OFF contact status irrespective of mounting or knob position even from a distance.

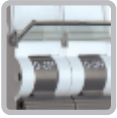

**Attractive Label Holder:**

Polycab MCB is provided with smoke grey coloured label holder which is positioned on top of the knob for inserting labels for circuit identification and hence reducing maintenance down time.



**Large & Dual Terminating Terminal Size:**

Polycab MCBs can accommodate cables upto 35sq.mm cross section area thus making it suitable for copper as well as aluminium cables. Both cable and busbar can be terminated at the in-comer.



**Bi-stable Din Clip Position:**

Convenience of mounting on Din Rail is easy with Polycab MCB. And also, The MCBs can be easily changed from a bank of devices connected by a busbar without disturbing your existing wiring.



**Air Circulation:**

When two or more poles are placed adjacent to each other, the designed depression in the body cover forms a tunnel and serves as paths for air circulation thus hot air is expelled out faster resulting in reduced body temperatures.



**Ease of Clamping:**

Input and output clamps on the MCB is provided with combi-head screws which have both the standard slot as well as double head which can be tightened by standard screwdriver as well as Philip screwdriver thus catering to tool availability.



**Enhanced Safety:**

Finger proof terminals are designed to eliminate accidental contact with live part complying with IP 20 protection category. Install, operate and maintain our MCBs with confidence.



**Energy Limiting Class-3:**

Rapid arc quenching mechanism in our MCB ensures extinguishing of the arc within quarter cycle (3 to 5 milliseconds) thus minimizing the energy flow through the circuit. This ensures minimizing risk of fire and maximizing the life of your equipment.



**Aesthetically Designed with Safety:**

Aesthetically designed Flame Retardant body ensures safety in case of accidental fire.



**High Quality Contact Tips:**

Silver graphite anti-weld contact tips ensure higher life and maximum safety against contact welding thus enhancing safety and life of the device.



**Energy Saver:**

values upto 70% lesser than specified by IEC/IS; making polycab MCB one of the most energy efficient MCB.

**MINIATURE CIRCUIT BREAKER (MCB)**

(In accordance with IS / IEC 60898-1) 240V, 50Hz, 10kA Breaking Capacity

B - Curve SP MCB			C - Curve SP MCB	
Rating (In)	Item Code	MRP/Unit ₹	Item Code	MRP/Unit ₹
6A	GMM101P001	207/-	GMM201P001	218/-
10A	GMM101P002	207/-	GMM201P002	218/-
16 A	GMM101P003	207/-	GMM201P003	218/-
20 A	GMM101P004	207/-	GMM201P004	218/-
25 A	GMM101P005	207/-	GMM201P005	218/-
32 A	GMM101P006	207/-	GMM201P006	218/-
40 A	GMM101P007	481/-	GMM201P007	521/-
63 A	-	-	GMM201P008	548/-



C - Curve SPN MCB			C - Curve DP MCB	
Rating (In)	Item Code	MRP/Unit ₹	Item Code	MRP/Unit ₹
6A	GMM201N001	701/-	GMM202P001	756/-
10A	GMM201N002	701/-	GMM202P002	756/-
16 A	GMM201N003	701/-	GMM202P003	756/-
20 A	GMM201N004	701/-	GMM202P004	756/-
25 A	GMM201N005	701/-	GMM202P005	756/-
32 A	GMM201N006	701/-	GMM202P006	756/-
40 A	GMM201N007	991/-	GMM202P007	1068/-
63 A	GMM201N008	1102/-	GMM202P008	1192/-



C - Curve TP MCB			C - Curve TPN MCB	
Rating (In)	Item Code	MRP/Unit ₹	Item Code	MRP/Unit ₹
6A	GMM203P001	1150/-	GMM203N001	1483/-
10A	GMM203P002	1150/-	GMM203N002	1483/-
16 A	GMM203P003	1150/-	GMM203N003	1483/-
20 A	GMM203P004	1150/-	GMM203N004	1483/-
25 A	GMM203P005	1150/-	GMM203N005	1483/-
32 A	GMM203P006	1150/-	GMM203N006	1483/-
40 A	GMM203P007	1716/-	GMM203N007	2102/-
63 A	GMM203P008	1865/-	GMM203N008	2260/-



C - Curve FP MCB		
Rating (In)	Item Code	MRP/Unit ₹
6A	GMM204P001	1639/-
10A	GMM204P002	1639/-
16 A	GMM204P003	1639/-
20 A	GMM204P004	1639/-
25 A	GMM204P005	1639/-
32 A	GMM204P006	1639/-
40 A	GMM204P007	2203/-
63 A	GMM204P008	2369/-



**Note:** Packing (Primary / Secondary / Master): SP-1 / 12 / 108; DP-1 / 6 / 54; TP-1 / 4 / 36; FP-1 / 3 / 27.



### MINIATURE CIRCUIT BREAKER (MCB)

(In accordance with IS / IEC 60898-1) 240V, 50Hz, 10kA Breaking Capacity

C - Curve SP MCB			C - Curve DP MCB	
Rating (In)	Item Code	MRP/Unit ₹	Item Code	MRP/Unit ₹
0.5A	GMM201P012	347/-	GMM202P012	1190/-
1A	GMM201P013	347/-	GMM202P013	1190/-
2A	GMM201P014	347/-	GMM202P014	1190/-
3A	GMM201P015	347/-	GMM202P015	1190/-
4A	GMM201P016	347/-	GMM202P016	1190/-
5A	GMM201P017	347/-	GMM202P017	1190/-



C - Curve TP MCB			C - Curve FP MCB	
Rating (In)	Item Code	MRP/Unit ₹	Item Code	MRP/Unit ₹
0.5A	GMM203P012	1800/-	GMM204P012	2200/-
1A	GMM203P013	1800/-	GMM204P013	2200/-
2A	GMM203P014	1800/-	GMM204P014	2200/-
3A	GMM203P015	1800/-	GMM204P015	2200/-
4A	GMM203P016	1800/-	GMM204P016	2200/-
5A	GMM203P017	1800/-	GMM204P017	2200/-



### ISOLATORS

(In accordance with IS/IEC 60947-3)

SP		
Rating (In)	Item Code	MRP/Unit ₹
40 A	GMS501P001	318/-
63 A	GMS501P002	376/-



DP		
Rating (In)	Item Code	MRP/Unit ₹
40 A	GMS502P001	455/-
63 A	GMS502P002	604/-
80 A	GMS502P003	778/-
100 A	GMS502P004	801/-
125 A	GMS502P005	885/-



TP			FP	
Rating (In)	Item Code	MRP/Unit ₹	Item Code	MRP/Unit ₹
40 A	GMS503P001	868/-	GMS504P001	1008/-
63 A	GMS503P002	985/-	GMS504P002	1109/-
80 A	GMS503P003	1231/-	GMS504P003	1455/-
100A	GMS503P004	1231/-	GMS504P004	1426/-
125A	GMS503P005	1296/-	GMS504P005	1517/-

**Note:** Packing (Primary / Secondary / Master): SP-1 / 12 / 108; DP-1 / 6 / 54; TP-1 / 4 / 36; FP-1 / 3 / 27.

**RESIDUAL CURRENT CIRCUIT BREAKER (RCCB)**

DP			
Rating (In)	Sensitivity	Item Code	MRP/Unit ₹
25A	30mA	GMR602P003	2770/-
	100mA	GMR602P009	2770/-
	300mA	GMR602P015	2821/-
40A	30mA	GMR602P005	2872/-
	100mA	GMR602P011	2872/-
	300mA	GMR602P017	2975/-
63A	30mA	GMR602P006	3487/-
	100mA	GMR602P012	3487/-
	300mA	GMR602P018	3590/-



FP			
Rating (In)	Sensitivity	Item Code	MRP/Unit ₹
25A	30mA	GMR604P003	3282/-
	100mA	GMR604P009	3282/-
	300mA	GMR604P015	3334/-
40A	30mA	GMR604P005	3385/-
	100mA	GMR604P011	3385/-
	300mA	GMR604P017	3436/-
63A	30mA	GMR604P006	3795/-
	100mA	GMR604P012	3795/-
	300mA	GMR604P018	3846/-



**Note:** Packing (Primary / Secondary / Master): DP- 1 / 6 / 36; FP- 1 / 3 / 18.

**RESIDUAL CURRENT CIRCUIT BREAKER WITH OVER CURRENT PROTECTION (RCBO)**

**NEW**

DP			
Rating (In)	Sensitivity	Item Code	MRP/Unit ₹
6A	30mA	GMB101N001	3250/-
	100mA	GMB201N001	3444/-
	300mA	GMB301N001	3444/-
10A	30mA	GMB101N002	3250/-
	100mA	GMB201N002	3444/-
	300mA	GMB301N002	3444/-
16A	30mA	GMB101N003	3250/-
	100mA	GMB201N003	3444/-
	300mA	GMB301N003	3444/-
20A	30mA	GMB101N004	3250/-
	100mA	GMB201N004	3444/-
	300mA	GMB301N004	3444/-
25A	30mA	GMB101N005	3250/-
	100mA	GMB201N005	3444/-
	300mA	GMB301N005	3444/-
32A	30mA	GMB101N006	3250/-
	100mA	GMB201N006	3444/-
	300mA	GMB301N006	3444/-
40A	30mA	GMB101N007	3347/-
	100mA	GMB201N007	3735/-
	300mA	GMB301N007	3735/-
63A	30mA	GMB101N008	4317/-
	100mA	GMB201N008	4511/-
	300mA	GMB301N008	4511/-



**Note:** Packing (Primary / Secondary / Master): DP-1 / NA / 12.

**RESIDUAL CURRENT CIRCUIT BREAKER WITH OVER CURRENT PROTECTION (RCBO)**

**NEW**



FP			
Rating (In)	Sensitivity	Item Code	MRP/Unit ₹
6A	30mA	GMB103N001	4123
	100mA	GMB203N001	4220
	300mA	GMB303N001	4220
10A	30mA	GMB103N002	4123
	100mA	GMB203N002	4220
	300mA	GMB303N002	4220
16A	30mA	GMB103N003	4123
	100mA	GMB203N003	3444
	300mA	GMB303N003	4220
20A	30mA	GMB103N004	4123
	100mA	GMB203N004	4220
	300mA	GMB303N004	4220
25A	30mA	GMB103N005	4123
	100mA	GMB203N005	4220
	300mA	GMB303N005	4220
32A	30mA	GMB103N006	4123
	100mA	GMB203N006	4220
	300mA	GMB303N006	4220
40A	30mA	GMB103N007	4220
	100mA	GMB203N007	4317
	300mA	GMB303N007	4317
63A	30mA	GMB103N008	4923
	100mA	GMB203N008	4996
	300mA	GMB303N008	4996

**Note:** Packing (Primary / Secondary / Master): 1 / NA / 8

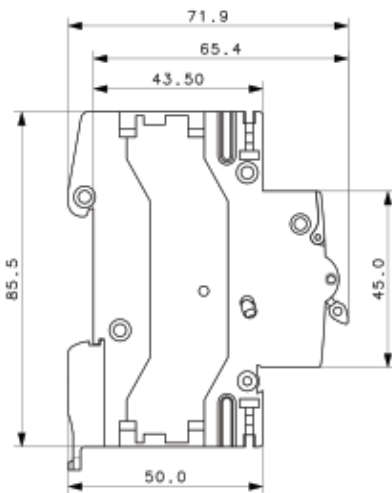

**Dimension details of MCB's / Isolators :**

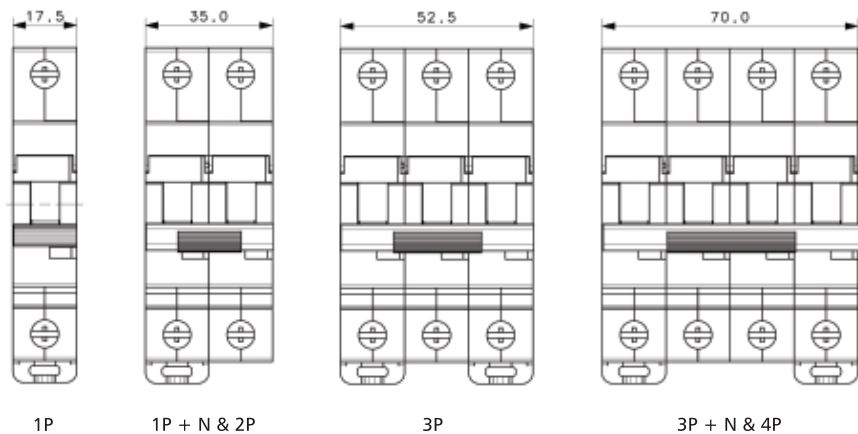

## Salient Features

- As per IS 13032/ 8623
- Aesthetically superior to suit the interiors.
- Suitable for flush and surface mounting.
- Ready to use DBs – provided with 100A phase bus-bar, Neutral bar, Cement spill Protector, Earth bar and Interconnecting wires as standard accessories.
- Provided with removable top and bottom gland plates With adequate knockouts for easy wiring.
- DBs made up of CRCA sheet steel & powder coated with RAL 9003 fine white shade.





### MCB ENCLOSURE

(In accordance with IS 13032, IS 8623, IEC / BSEN 61439-3)  
RAL - 9003 fine white texture

#### MCB Enclosure (Cut-Out)

In Sheet Steel, Suitable for 2P/4P Devices

No. Of Ways	No. of Poles	Item Code	MRP/Unit ₹
2W	DP	GPDSN10002	371/-
4W	FP	GPDTN10002	436/-



### PLUG & SOCKETS

(In accordance with IS 13032, IS 8623, IEC / BSEN 61439-3)  
RAL - 9003 fine white texture

#### Plug & Socket Board, With Metal Plug & Socket, 1P+N/3P & Earth

Rating	No. of Poles	Item Code	MRP/Unit ₹
20A	SP	GPDPS10006	709/-
20A	DP	GPDPS10004	970/-
20A	TP	GPDPS10005	1744/-
30A	TP	GPDPS20003	2698/-



### SPN DISTRIBUTION BOARD

(In accordance with IS 13032, IS 8623, IEC / BSEN 61439-3)  
RAL - 9003 fine white texture IP 30 - Single Door DB

#### SPN Distribution Board (Suitable for DP Incoming and SP Outgoing)

No. Of Ways	Item Code Single Door	MRP/Unit ₹
4W	GPDSN10016	937/-
6W	GPDSN10017	1008/-
8W	GPDSN10018	1068/-
12W	GPDSN10019	1493/-
16W	GPDSN10020	1908/-



### TPN DISTRIBUTION BOARD

(In accordance with IS 13032, IS 8623, IEC / BSEN 61439-3)  
RAL - 9003 fine white texture, IP 30 - Single Door DB

#### TP&N Distribution Board (Suitable for FP Incoming and SP Outgoing)

No. Of Ways	I/C + O/G Ways	Item Code Single Door	MRP/Unit ₹
4W	4+12	GPDTN10031	2671/-
4W	8+12	GPDTN10032	2943/-
6W	8+18	GPDTN10033	3188/-
8W	8+24	GPDTN10034	3706/-
12W	8+36	GPDTN10030	5150/-



## SPN DISTRIBUTION BOARD

RAL - 9003 fine white texture  
IP 42 - Double Door DB

### SPN Distribution Board (Suitable for DP Incoming and SP Outgoing)

No. Of Ways	Item Code Double Door	MRP/Unit ₹
4W	GPDSN20016	1308/-
6W	GPDSN20012	1537/-
8W	GPDSN20017	1771/-
12W	GPDSN20018	2153/-
16W	GPDSN20019	2889/-

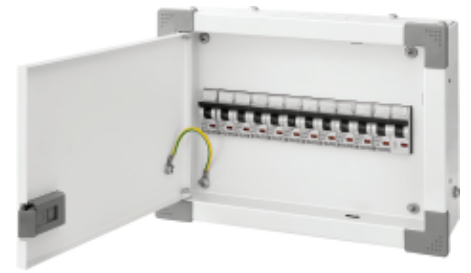

## TPN DISTRIBUTION BOARD

RAL - 9003 fine white texture  
IP 42 - Double Door DB

### TPN Distribution Board (Suitable for FP Incoming and SP Outgoing)

No. Of Ways	I/C + O/G Ways	Item Code Double Door	MRP/Unit ₹
4W	4+12	GPDTN20064	3379/-
4W	8+12	GPDTN20065	3537/-
6W	8+18	GPDTN20066	4360/-
8W	8+24	GPDTN20067	5396/-
12W	8+36	GPDTN20068	8284/-



## SPN ACRYLIC DISTRIBUTION BOARD

RAL - 9003 fine white texture  
IP 42 - Double Door DB

**NEW**

### SPN Distribution Board (Suitable for DP Incoming and SP Outgoing)

No. Of Ways	Item Code Double Door	MRP/Unit ₹
4W	GPDSN30006	1439/-
6W	GPDSN30007	1690/-
8W	GPDSN30008	1951/-
12W	GPDSN30009	2369/-
16W	GPDSN30010	3177/-



## TPN ACRYLIC DISTRIBUTION BOARD

RAL - 9003 fine white texture  
IP 42 - Double Door DB

**NEW**

### TPN Distribution Board (Suitable for FP Incoming and SP Outgoing)

No. Of Ways	I/C + O/G Ways	Item Code Single Door	MRP/Unit ₹
4W	4 + 12	GPDTN30006	3886/-
4W	8 + 12	GPDTN30007	4068/-
6W	8 + 18	GPDTN30008	5014/-
8W	8 + 24	GPDTN30009	6205/-
12W	8 + 36	GPDTN30010	9527/-





### TPN VERTICAL DISTRIBUTION BOARD

(In accordance with IS 13032, IS 8623, IEC / BSEN 61439-3)  
RAL - 9003 fine white texture, IP 42 - Double Door DB

TPN Vertical Distribution Board (Suitable for FP Incoming and SP / TP Outgoing)

No. Of Ways	I/C + O/G Ways	Item Code Double Door	MRP/Unit ₹
4W	8+12	GPDTN20069	8666/-
6W	8+18	GPDTN20070	9810/-
8W	8+24	GPDTN20071	10900/-
12W	8+36	GPDTN20072	15369/-



### TPN PPI HORIZONTAL DISTRIBUTION BOARD

(In accordance with IS 13032, IS 8623, IEC / BSEN 61439-3)  
RAL - 9003 fine white texture, IP 42 - Double Door DB

TP&N Distribution Board, Per Phase Isolated Neutral  
(Suitable for FP Incoming and SP Outgoing)

No. Of Ways	I/C + O/G Ways	Item Code Double Door	MRP/Unit ₹
4W	8+6+12	GPDTN20077	5150/-
6W	8+6+18	GPDTN20078	7358/-
8W	8+6+24	GPDTN20079	9701/-
12W	8+6+36	GPDTN20080	12862/-



### TPN PPI VERTICAL DISTRIBUTION BOARD

(In accordance with IS 13032, IS 8623, IEC / BSEN 61439-3)  
RAL - 9003 fine white texture, IP 42 - Double Door DB

TP&N Distribution Board, Per Phase Isolated Neutral  
(Suitable for FP Incoming and SP Outgoing)

No. Of Ways	I/C + O/G Ways	Item Code Double Door	MRP/Unit ₹
4W	8+6+12	GPDTN20046	5667/-
6W	8+6+18	GPDTN20047	8093/-
8W	8+6+24	GPDTN20048	10671/-
12W	8+6+36	GPDTN20049	14148/-



### FLEXY TIER DISTRIBUTION BOARD

Flexibility of Choosing Incomer & Outgoing as per your requirement  
RAL - 9003 fine white texture  
IP 42 - Double Door DB

**NEW**

Distribution Board, With Total Installation Flexibility

No. Of Ways	No of Modules	Item Code Double Door	MRP/Unit ₹
2 Row of 12 Mod	24	GPDTN20052	2834/-
3 Row of 12 Mod	36	GPDTN20053	3815/-
4 Row of 10 Mod	40	GPDTN20054	4578/-
4 Row of 14 Mod	56	GPDTN20055	5396/-

## TPN PHASE SELECTOR

(In accordance with IS 13032, IS 8623, IEC / BSEN 61439-3)  
RAL - 9003 fine white texture, IP 42 - Double Door DB

**Phase Selector Distribution Board, Vertical Config.**  
Suitable for 8 way incomer and SP Outgoing with Rotary Switches (for Manual Phase Selection) and indicating Light, Duly Wired

Selector Rating	No. Of Ways	Item Code Single Door	MRP/Unit ₹	Item Code Double Door	MRP/Unit ₹
40 A	4 W	GPDTN10035	9892/-	GPDTN30021	11227/-
40 A	6 W	GPDTN10037	10137/-	GPDTN30023	11990/-
40 A	8 W	GPDTN10039	11173/-	GPDTN30025	12971/-
63 A	4 W	GPDTN10036	11227/-	GPDTN30022	12862/-
63 A	6 W	GPDTN10038	11990/-	GPDTN30024	13625/-
63 A	8 W	GPDTN10040	12971/-	GPDTN30026	14606/-



## TPN DISTRIBUTION BOARD, 7 SEGMENT

(In accordance with IS 13032, IS 8623, IEC / BSEN 61439-3)  
RAL - 9003 fine white texture, IP 42 - Double Door DB

**TPN Distribution Board, Special Purpose, 7 Segment, Per Phase Isolated Neutral**  
(Suitable for FP Incoming and SP Outgoing with Provision of DP RCCB Protection)

No. Of Ways	I/C + O/G Ways	Item Code Double Door	MRP/Unit ₹
4W	8+6+12	GPDTN20073	7374/-
6W	8+6+18	GPDTN20074	8993/-
8W	8+6+24	GPDTN20075	11936/-
12W	8+6+36	GPDTN20076	14334/-



## TPN DISTRIBUTION BOARD, 8 SEGMENT

(In accordance with IS 13032, IS 8623, IEC / BSEN 61439-3)  
RAL - 9003 fine white texture, IP 42 - Double Door DB

**NEW**

**TPN Distribution Board, Special Purpose, 8 Segment, Per Phase Isolated Neutral**  
(Suitable for FP Incoming and SP Outgoing with Provision of DP RCCB Protection)

No. Of Ways	Item Code Double Door	MRP/Unit ₹
4W	GPDTN20083	7670/-
6W	GPDTN20084	9352/-
8W	GPDTN20085	12414/-
12W	GPDTN20086	14908/-



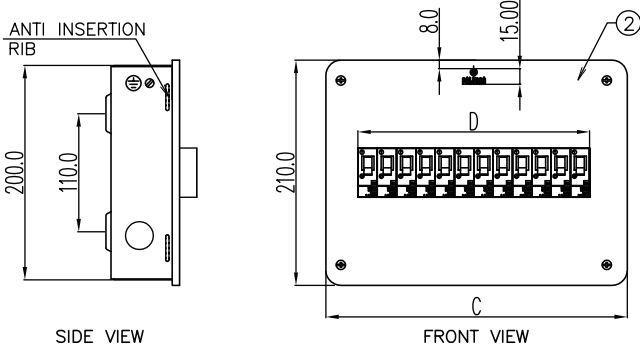

**GA DRAWINGS FOR -**  
SPN DB: IP-30 (Single Door)

WAY	A	B	C	D
4	132	62	142	72
6	168	98	178	108
8	204	134	214	144
12	276	206	286	216
16	348	278	358	288

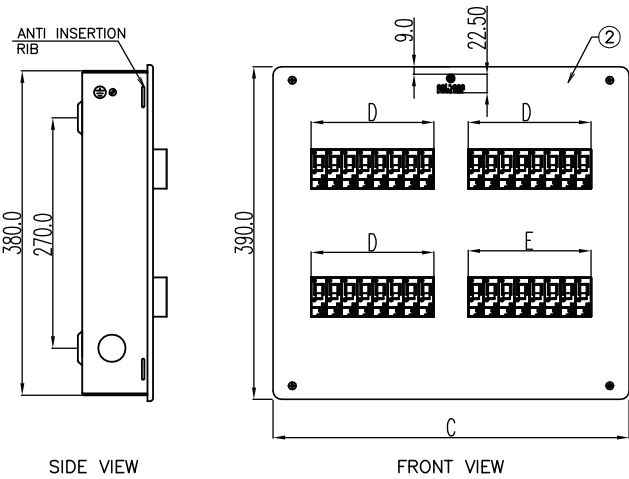
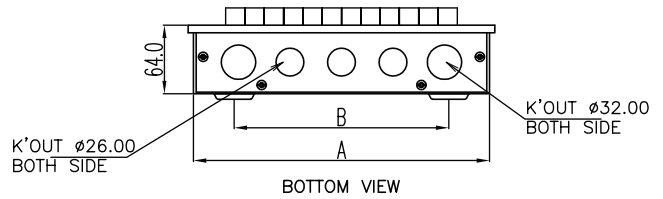

**GA DRAWINGS FOR -**  
TPN DB: IPN-30 (Single Door)

WAY	A	B	C	D	E
04	263	188	273	72	72
04	335	260	345	72	144
06	371	296	381	108	144
08	407	332	417	144	144
12	551	476	561	216	144

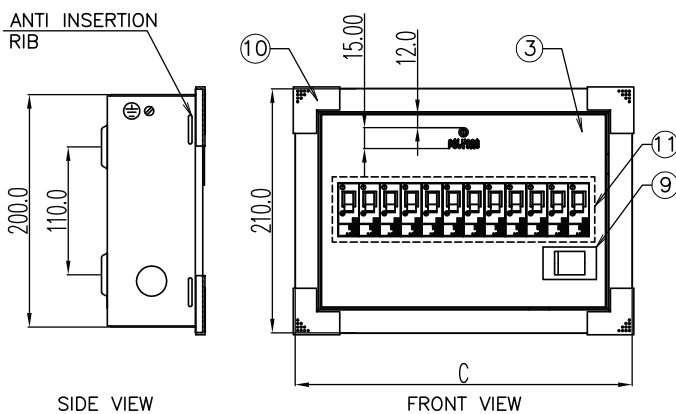
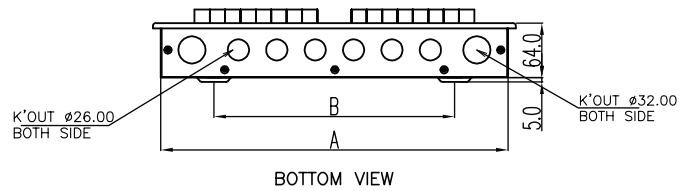

**GA DRAWINGS FOR -**  
SPN DB: IP-42 (Double Door)

WAY	A	B	C	D
4	136	62	146	72
6	172	92	182	108
8	208	128	218	144
10	244	164	254	180
12	280	200	290	216
16	352	272	362	288

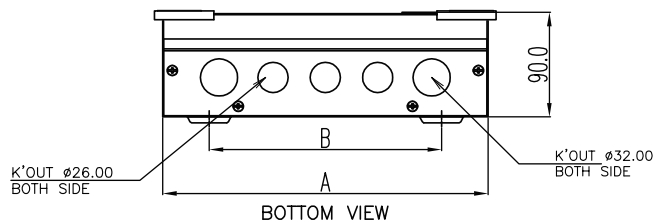

## GA DRAWINGS FOR - TPN DB: IP-42 (Double Door)

WAY	A	B	C	D	E
04	263	188	273	72	72
04	335	260	345	72	144
06	371	296	381	108	144
08	407	332	417	144	144
12	551	476	561	216	144

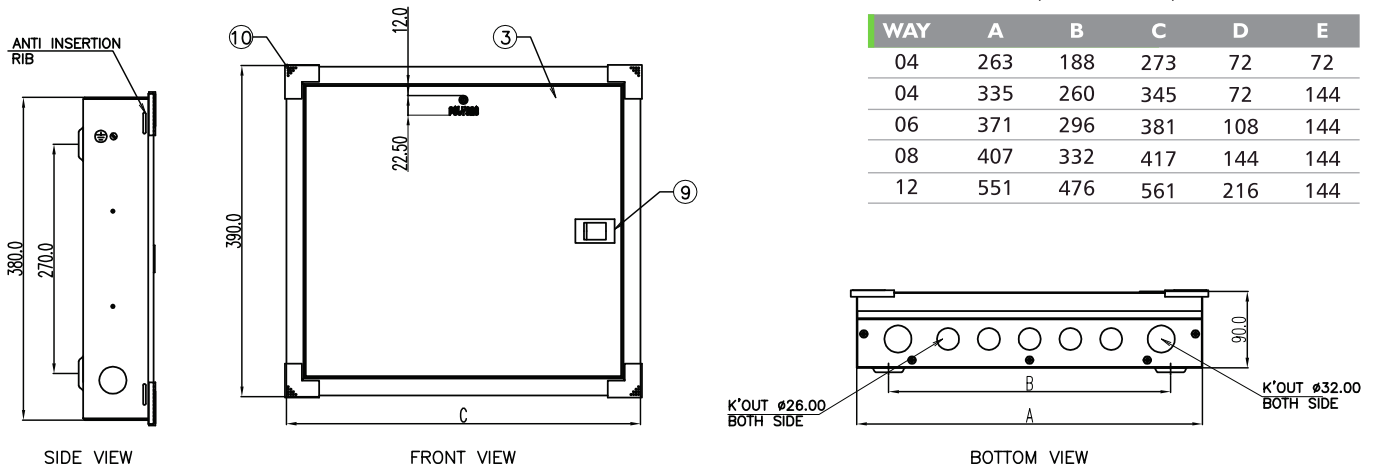

### DB - Features

Conform IS 13032 / 8623  
Adequate Knockout for wiring  
Flush & Surface Mounting

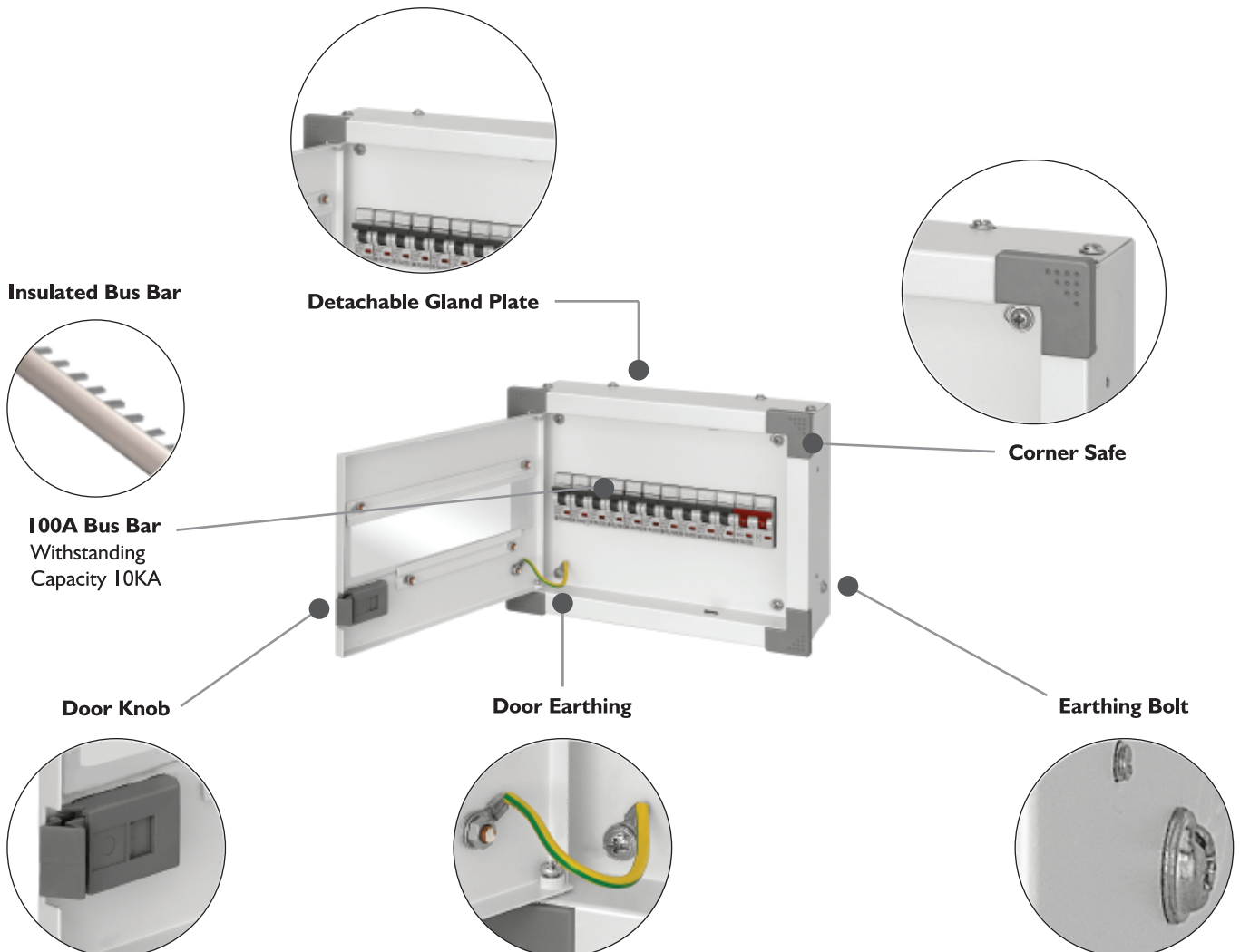

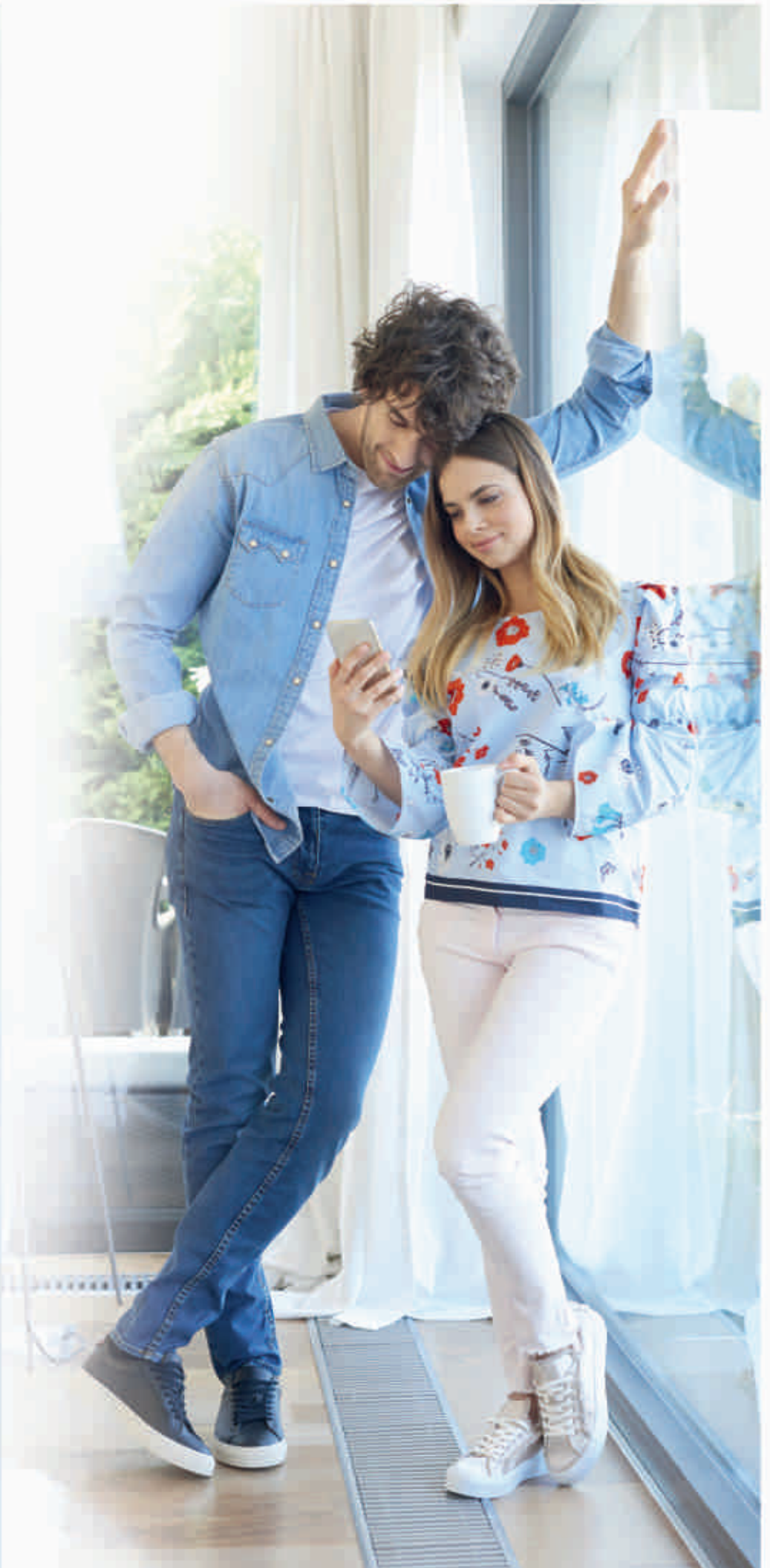

### Salient Features:

- ▮ Double rocker Mechanism-  
Soundless soft touch
- ▮ FR Polycarbonate,
- ▮ Bimetal contacts with Silver Tip
- ▮ Also available with  
touch and remote

**CAPRINA**  
SERIES

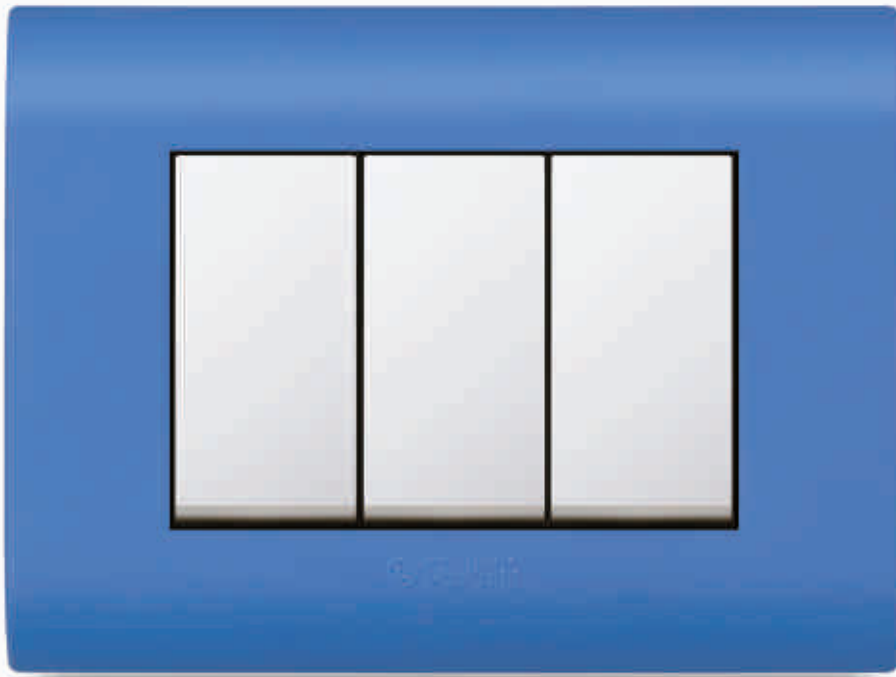

BLUE

**CURVE PLATES**



WHITE



MAGNESIUM GREY



BLUE



PINK



### Salient Features:

- ▮ Double rocker Mechanism-  
Soundless soft touch
- ▮ FR Polycarbonate,
- ▮ Bimetal contacts with Silver Tip
- ▮ Also available with  
touch and remote





WHITE



BLACK



CHOCOLATE

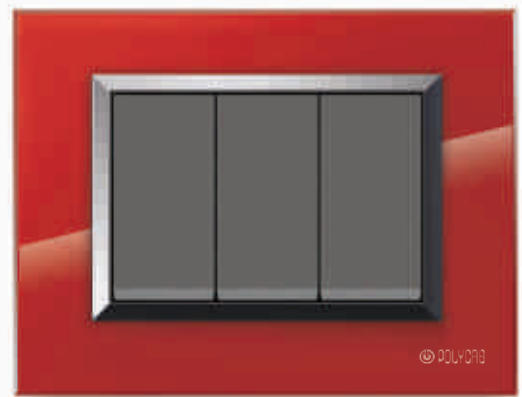

RED



FROSTED MIRROR

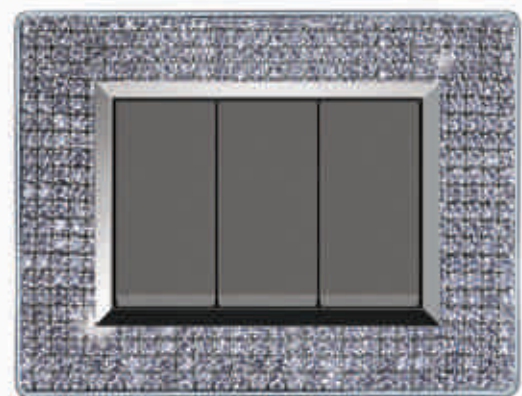

CRYSTAL



### Salient Features:

- | Double rocker Mechanism-  
Soundless soft touch
- | FR Polycarbonate,
- | Bimetal contacts with Silver Tip
- | Also available with  
touch and remote



WHITE



CHAMPAGNE GOLD

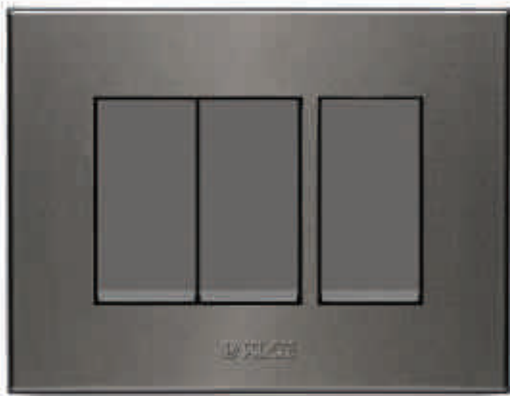

MAGNESIUM GREY



BLACK

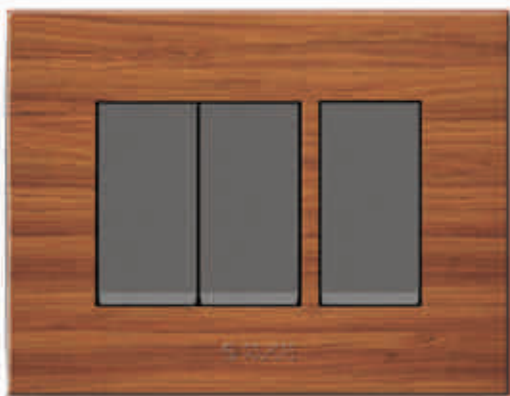

NATURAL WOOD



AFRICAN WENGE

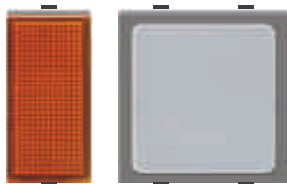
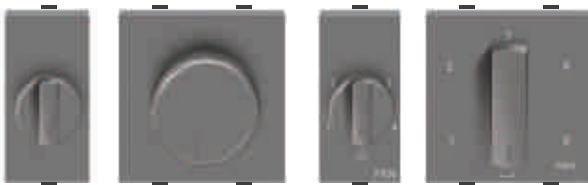
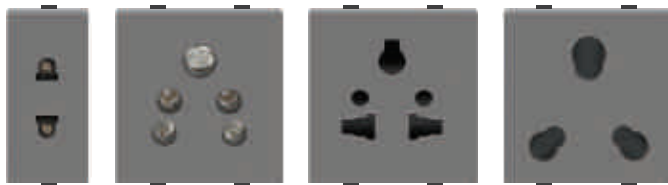
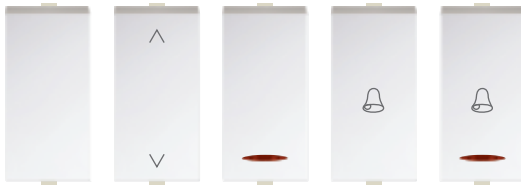
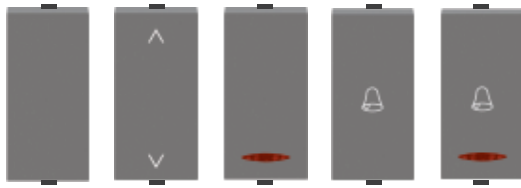

Code	Item Description	Module	MRP/Unit ₹		Pkg.
			White	Mag. Grey	

## 10A / 16A SWITCHES

SLV0100601/02	10A 1-way Switch	1M	105/-	117/-	20 / 400
SLV0100701/02	10A 2-way Switch	1M	135/-	148/-	20 / 120
SLV0100801/02	10A 1-way Switch w/ind.	1M	135/-	148/-	20 / 120
SLV0100901/02	10A Bell Push	1M	136/-	149/-	20 / 120
SLV0101001/02	10A Bell Push w/ind.	1M	152/-	167/-	20 / 120
SLV0101101/02	16A 1-way Switch	1M	152/-	167/-	20 / 200
SLV0101201/02	16A 2-way Switch	1M	197/-	215/-	20 / 120
SLV0101301/02	16A 1-way Switch w/ind.	1M	197/-	215/-	20 / 200

## 10A / 16A SWITCHES PRO

SLV3100601/02	10A 1-Way Switch Pro	1M	105/-	117/-	20 / 400
SLV3100701/02	10A 2-Way Switch Pro	1M	135/-	148/-	20 / 120
SLV3100801/02	10A 1-Way Switch w/Ind. Pro	1M	135/-	148/-	20 / 120
SLV3100901/02	10A Bell Push Pro	1M	136/-	141/-	20 / 120
SLV3101001/02	10A Bell Push w/Ind. Pro	1M	152/-	158/-	20 / 120
SLV3101101/02	16A 1-Way Switch Pro	1M	152/-	167/-	20 / 200
SLV3101201/02	16A 2-Way Switch Pro	1M	197/-	215/-	20 / 120
SLV3101301/02	16A 1-Way Switch w/Ind. Pro	1M	197/-	215/-	20 / 200

## 10A / 16A SWITCHES

SLV0101701/02	10A 1-way Switch w/ind.	2M	172/-	190/-	10 / 100
SLV0101901/02	10A Bell Push w/ind.	2M	178/-	197/-	10 / 100
SLV0102001/02	16A 1-way Switch w/ind.	2M	229/-	244/-	10 / 100
SLV0102301/02	32A DP 1-way Switch w/ind.	2M	310/-	363/-	10 / 100

## SOCKETS

SLV0200101/02	6A 2-Pin Socket Outlet Euro	1M	104/-	114/-	20 / 120
SLV0200201/02	6A 5-Pin Socket Outlet	2M	106/-	115/-	10 / 100
SLV0200301/02	6A Socket Outlet-Multi	2M	149/-	165/-	10 / 200
SLV0200501/02	6/16A Twin Socket Outlet Shuttered	2M	235/-	255/-	10 / 100
SLV0200601/02	6/25 A Universal Socket	2M	288/-	316/-	10 / 100
SLV0200701/02	6/16A Twin Socket Outlet Shuttered (for Glass Plates)	2M	248/-	273/-	10 / 100

## DIMMER / FAN REGULATOR

SLV0300101/02	Dimmer 400w	1 M	306/-	322/-	10 / 100
SLV0300201/02	Dimmer 400w	2 M	446/-	476/-	10 / 100
SLV0300301/02	4-Step 360-deg. Fan Regulator	1 M	414/-	455/-	10 / 100
SLV0300401/02	5-Step 360-deg. Fan Regulator	2 M	489/-	536/-	10 / 100

## NEON INDICATOR / NIGHT LAMP

SLV0300501	Neon Indicator 230V	1 M	126/-		20 / 120
SLV0300601/02	Night Lamp 230V	2 M	347/-	374/-	10 / 60

Code	Item Description	Module	MRP/Unit ₹		Pkg.
			White	Mag. Grey	

### BUZZER / FOOT-LIGHT / LED WITH SHRINK SLEEVE

SLV0300701/02	Electronic Buzzer 230V	2 M	252/-	272/-	10 / 60
SLV0300801/02	Foot-light w/3-LED 230V	2 M	359/-	394/-	10 / 60
SLV0300900	L.E.D With Shrink Sleeve		30/-		30 / 300

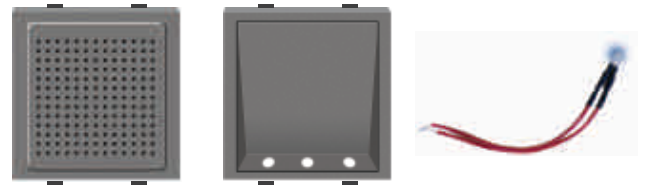

### TELEPHONE SOC. / CAT-5 / CAT-6 / TV SOCKET

SLV0400101/02	RJ-11 Telephone Socket Shutterd 2L	1 M	152/-	167/-	20 / 120
SLV0400201/02	RJ-11 Telephone socket 4L	1 M	186/-	203/-	20 / 120
SLV0400301/02	RJ-45 Krone Jack CAT-5 Shuttered	1 M	376/-	409/-	10 / 100
SLV0400401/02	RJ-45 Krone Jack CAT-6 Shuttered	1 M	665/-	725/-	10 / 100
SLV0400501/02	TV Co-axial Socket	1 M	142/-	156/-	20 / 120



### DND TOUCH PANEL (INDOOR & OUTDOOR) / ELECTRONIC SWITCH

SLV0500101/02	Do Not Disturb Indicator Unit (Outside)	1M	138/-	137/-	20 / 120
SLV0500701/02	Make My Room Indicator Unit (Outside)	1M	138/-	138/-	20 / 120
SLV0500801/02	Pick My Laundry Indicator Unit (Outside)	1M	138/-	138/-	20 / 120
SLV0500201/02	Do Not Disturb Switch With LED (Inside)	1M	149/-	162/-	20 / 120
SLV0500901/02	Make My Room Switch With LED (Inside)	1M	149/-	162/-	20 / 120
SLV0501001/02	Pick My Laundry Switch With LED (Inside)	1M	149/-	162/-	20 / 120
SLV0500501/02	25 A Electronic Switch With Card	3M	2231/-	2360/-	5 / 30
SLV0500601	Electronic Card Only		119/-		



### BLANK PLATE

SLV0800101/02	Blank Plate	1 M	23/-	30/-	30 / 300
---------------	-------------	-----	------	------	----------



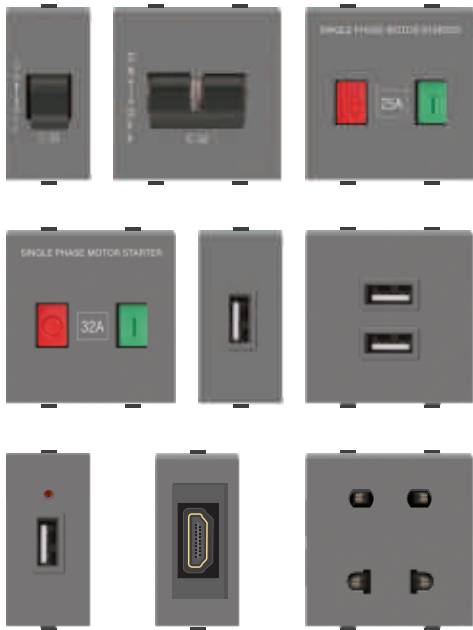

Code	Item Description	Module	MRP/Unit ₹		Pkg.
			White	Mag. Grey	
<b>MINI MCBS / MOTOR STARTER SWITCH / USB CHARGER</b>					
SLV0710601/02	6A 1P Mini MCB	1M	296/-	328/-	10 / 100
SLV0711001/02	10A 1P Mini MCB	1M	296/-	328/-	10 / 100
SLV0711601/02	16A 1P Mini MCB	1M	296/-	328/-	10 / 100
SLV0712001/02	20A 1P Mini MCB	1M	296/-	328/-	10 / 100
SLV0712501/02	25A 1P Mini MCB	1M	296/-	328/-	10 / 100
SLV0713201/02	32A 1P Mini MCB	1M	296/-	328/-	10 / 100
SLV0720601/02	6A 1P+N Mini MCB	2M	631/-	695/-	10 / 60
SLV0721001/02	10A 1P+N Mini MCB	2M	631/-	695/-	10 / 60
SLV0721601/02	16A 1P+N Mini MCB	2M	631/-	695/-	10 / 60
SLV0722001/02	20A 1P+N Mini MCB	2M	631/-	695/-	10 / 60
SLV0722501/02	25A 1P+N Mini MCB	2M	631/-	695/-	10 / 60
SLV0723201/02	32A 1P+ N Mini MCB	2M	631/-	695/-	10 / 60
SLV1022501/02	25A 1P+N Motor Starter Switch	2M	654/-	714/-	10 / 60
SLV1023201/02	32A 1P+N Motor Starter Switch	2M	654/-	714/-	10 / 60
SLV1800101/02	1A USB Charger 1000mA/5V	1M	982/-	1071/-	10 / 100
SLV1800201/02	2A USB Charger 2000mA/5V	2M	1301/-	1362/-	10 / 60
SLV1800401/02	2A USB Charger with Charging indication	1M	1222/-	1344/-	10/100
SLV0400601/02	HDMI Socket	1M	1228/-	1350/-	10/100
SLV0400701/02	Shaver Socket	2M	1473/-	1620/-	10/60

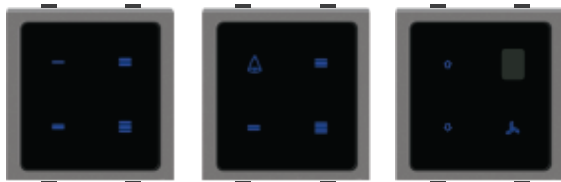

## IR TOUCH SCREEN SWITCH / FAN REGULATOR & LIGHT DIMMER /16A/30A

SLV1400101/02	4 Switch IR Touch Screen	2M	5005/-	5363/-	5 / 30
SLV1400201/02	3 Switch 1 Bell IR Touch Screen	2M	5005/-	5363/-	5 / 30
SLV1400301/02	Fan Regulator IR 8 Step Touch Screen	2M	5482/-	5840/-	5 / 30



SLV1400401/02	Light Dimmer IR 9 Step 300W Touch Screen	2M	5482/-	5840/-	5 / 30
SLV1400501/02	16A Switch w/ind. IR Touch Screen	2M	4171/-	4409/-	5 / 30
SLV1400601/02	30A Switch w/ind. IR Touch Screen	2M	4171/-	4409/-	5 / 30

Code	Item Description	Module	MRP/Unit ₹ Mag. Grey		Pkg.
------	------------------	--------	-------------------------	--	------

### IR TOUCH SCREEN -DND/ CLEAN MY ROOM / BELL SWITCH/ REMOTE CONTROL

SLV1400701/02	DND/ Clean My Room Indicator With bell IR Touch Screen Outdoor	2M	4171/-	4409/-	5 / 30
SLV1400801/02	DND/ Clean My Room IR Touch Screen Indoor Unit	2M	4171/-	4409/-	5 / 30
SLV1400901/02	Bell Switch IR Touch Screen	2M	3575/-	3814/-	5 / 30
SLV1401000	Remote Control Unit Touch Pad			1907/-	5 / 30



### 1/2/3/4 SWITCH AND 2 SWITCH 1 BELL TOUCH FEEL

SLV1600102	1 Switch Touch Feel	2M	3551/-		5 / 30
SLV1600202	2 Switch Touch Feel	2M	4171/-		5 / 30
SLV1600302	4 Switch Touch Feel	2M	5363/-		5 / 30
SLV1600402	3 Switch 1 Bell Touch Feel	2M	5363/-		5 / 30

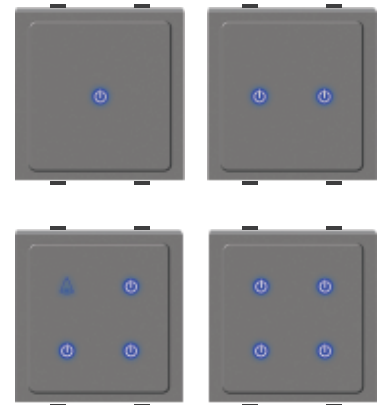

### FAN REGULATOR / LIGHT DIMMER TOUCH FEEL

SLV1600502	Fan Regulator 8 Step Touch Feel	2M	5840/-		5 / 30
SLV1600602	Light Dimmer 9 Step 300W Touch Feel	2M	5840/-		5 / 30
SLV1600702	16A Switch w/ind. Touch Feel	2M	4409/-		5 / 30
SLV1600802	30A Switch w/ind. Touch Feel	2M	4409/-		5 / 30
SLV1600902	Bell Switch Touch Feel	2M	3814/-		5 / 30

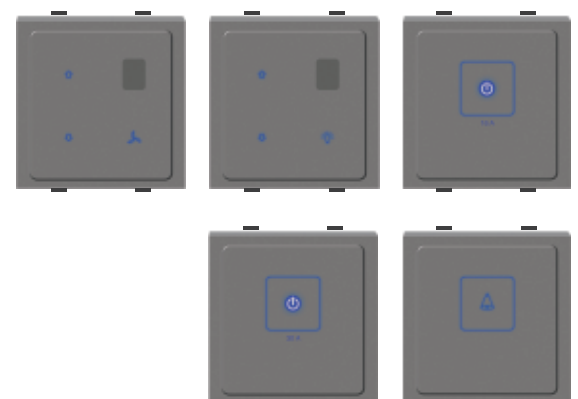

## GLASS COVER PLATES (Available Colours)



WHITE



SILVER



BLACK



RED



CHOCOLATE



FROSTED MIRROR

GLASS PLATES-FLAT ( COLOURS)									
MODULES	1M	2M	3M	4M	6M	8M (H.)	8M (Sq.)	12M	18M
	CODE	CODE	CODE	CODE	CODE	CODE	CODE	CODE	CODE
WHITE	SLV1100101	SLV1100201	SLV1100301	SLV1100401	SLV1100601	SLV1100801	SLV11S0801	SLV1101201	SLV1101801
SILVER	SLV1100103	SLV1100203	SLV1100303	SLV1100403	SLV1100603	SLV1100803	SLV11S0803	SLV1101203	SLV1101803
BLACK	SLV1100104	SLV1100204	SLV1100304	SLV1100404	SLV1100604	SLV1100804	SLV11S0804	SLV1101204	SLV1101804
RED	SLV1100105	SLV1100205	SLV1100305	SLV1100405	SLV1100605	SLV1100805	SLV11S0805	SLV1101205	SLV1101805
CHOCOLATE	SLV1100114	SLV1100214	SLV1100314	SLV1100414	SLV1100614	SLV1100814	SLV11S0814	SLV1101214	SLV1101814
M.R.P. ₹	595/-	595/-	775/-	952/-	1191/-	1519/-	1359/-	1906/-	2294/-

GLASS PLATES-BEVELLED EDGE									
MODULES	1M	2M	3M	4M	6M	8M (H.)	8M (Sq.)	12M	18M
	CODE	CODE	CODE	CODE	CODE	CODE	CODE	CODE	CODE
	SLV1200113	SLV1200213	SLV1200313	SLV1200413	SLV1200613	SLV1200813	SLV12S0813	SLV1201213	SLV1201813
M.R.P. ₹	714/-	833/-	1107/-	1360/-	1701/-	2170/-	1941/-	2722/-	3277/-

Glass Plates Pkg.	5 / 60	5 / 60	5 / 60	5 / 40	5 / 30	5 / 20	5 / 20	5 / 20	5 / 15
-------------------	--------	--------	--------	--------	--------	--------	--------	--------	--------

GLASS PLATES -SUPPORT FRAMES									
MODULES	2M	3M	4M	6M	8M (H.)	8M (Sq.)	12M	18M	
	CODE	CODE	CODE	CODE	CODE	CODE	CODE	CODE	CODE
	SLV1300200	SLV1300300	SLV1300400	SLV1300600	SLV1300800	SLV13S0800	SLV1301200	SLV1301800	
M.R.P. ₹	58/-	70/-	79/-	201/-	244/-	244/-	332/-	447/-	

Support Plates Pkg.	10 / 100	10 / 100	10 / 100	5 / 50	5 / 50	5 / 50	5 / 50	5 / 25	
---------------------	----------	----------	----------	--------	--------	--------	--------	--------	--



## COVER PLATES (Available Colours)



WHITE

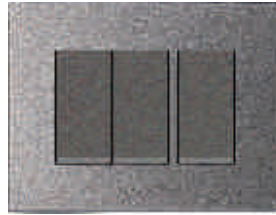

MAGNESIUM GREY



BLACK



CHAMPAGNE GOLD



AFRICAN WENGE

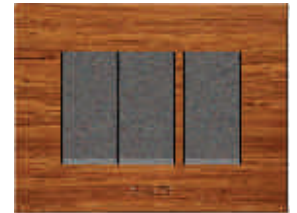

NATURAL WOOD



TEAK WOOD

### GLOSSY WHITE WITH BLACK BASE

MODULES	1M	2M	3M	4M	6M	8M (H.)	8M (Sq.)	12M	16M	18M
CODE	SLV0900101	SLV0900201	SLV0900301	SLV0900401	SLV0900601	SLV0900801	SLV09S0801	SLV0901201	SLV0901601	SLV0901801
M.R.P. ₹	96/-	96/-	117/-	140/-	191/-	244/-	244/-	289/-	318/-	351/-

### GLOSSY WHITE WITH WHITE BASE

MODULES	1M	2M	3M	4M	6M	8M (H.)	8M (Sq.)	12M	16M	18M
CODE	SLV0900112	SLV0900212	SLV0900312	SLV0900412	SLV0900612	SLV0900812	SLV09S0812	SLV0901212	SLV0901612	SLV0901812
M.R.P. ₹	96/-	96/-	177/-	140/-	191/-	244/-	244/-	289/-	318/-	351/-

**NEW**

### COLOURS

MODULES	1M	2M	3M	4M	6M	8M (H.)	8M (Sq.)	12M	16M	18M
	CODE	CODE	CODE	CODE	CODE	CODE	CODE	CODE	CODE	CODE
MAGNESIUM GREY	SLV0900102	SLV0900202	SLV0900302	SLV0900402	SLV0900602	SLV0900802	SLV09S0802	SLV0901202	SLV0901602	SLV0901802
BLACK	SLV0900106	SLV0900206	SLV0900306	SLV0900406	SLV0900606	SLV0900806	SLV09S0806	SLV0901206	SLV0901606	SLV0901806
CHAMPAGNE GOLD	SLV0900107	SLV0900207	SLV0900307	SLV0900407	SLV0900607	SLV0900807	SLV09S0807	SLV0901207	SLV0901607	SLV0901807
M.R.P. ₹	147/-	147/-	191/-	215/-	276/-	369/-	369/-	460/-	490/-	520/-

### WOODEN FINISH

MODULES	1M	2M	3M	4M	6M	8M (H.)	8M (Sq.)	12M	16M	18M
	CODE	CODE	CODE	CODE	CODE	CODE	CODE	CODE	CODE	CODE
AFRICAN WENGE	SLV0900108	SLV0900208	SLV0900308	SLV0900408	SLV0900608	SLV0900808	SLV09S0808	SLV0901208	SLV0901608	SLV0901808
TEAK WOOD	SLV0900109	SLV0900209	SLV0900309	SLV0900409	SLV0900609	SLV0900809	SLV09S0809	SLV0901209	SLV0901609	SLV0901809
NATURAL WOOD	SLV0900110	SLV0900210	SLV0900310	SLV0900410	SLV0900610	SLV0900810	SLV09S0810	SLV0901210	SLV0901610	SLV0901810
M.R.P. ₹	183/-	183/-	244/-	295/-	398/-	520/-	520/-	643/-	674/-	706/-

Pkg.	10 / 100	10 / 100	10 / 100	10 / 100	5 / 50	5 / 50	5 / 50	5 / 50	5 / 25	5 / 25
------	----------	----------	----------	----------	--------	--------	--------	--------	--------	--------

### CURVE PLATES (Available Colours)



WHITE



MAGNESIUM GREY



PINK

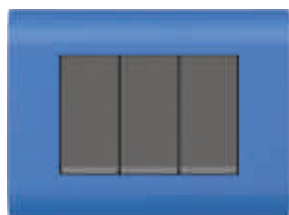

BLUE

#### CURVE - WHITE

MODULES	1M	2M	3M	3M /PARTITION	4M	6M	8M (H.)	8M (Sq.)	12M	18M
CODE	SLV0900113	SLV0900213	SLV0900313	SLV09P0314	SLV0900413	SLV0900613	SLV0900813	SLV09S0813	SLV0901213	SLV0901813
M.R.P ₹	96/-	96/-	117/-	117/-	140/-	191/-	244/-	244/-	289/-	351/-

#### NEW

#### CURVE - COLOUR

MODULES	1M	2M	3M	3M /PARTITION	4M	6M	8M (H.)	8M (Sq.)	12M	18M
CODE	CODE	CODE	CODE	CODE	CODE	CODE	CODE	CODE	CODE	CODE
MAGNESIUM GREY	SLV3109102	SLV3109202	SLV3109302	SLV3109P302	SLV3109402	SLV3109602	SLV3109802	SLV3109S802	SLV3109122	SLV3109182
PINK	SLV3109103	SLV3109203	SLV3109303	SLV3109P303	SLV3109403	SLV3109603	SLV3109803	SLV3109S803	SLV3109123	SLV3109183
BLUE	SLV3109104	SLV3109204	SLV3109304	SLV3109P304	SLV3109404	SLV3109604	SLV3109804	SLV3109S804	SLV3109124	SLV3109184
M.R.P ₹	147/-	147/-	191/-	191/-	215/-	313/-	369/-	369/-	460/-	520/-

#### NEW

Pkg.	10/100	10/100	10/100	10/100	10/100	5/50	5/50	5/50	5/50	5/25
------	--------	--------	--------	--------	--------	------	------	------	------	------

## GLASS COVER PLATES (Available Sizes, DIMENSION IN mm)

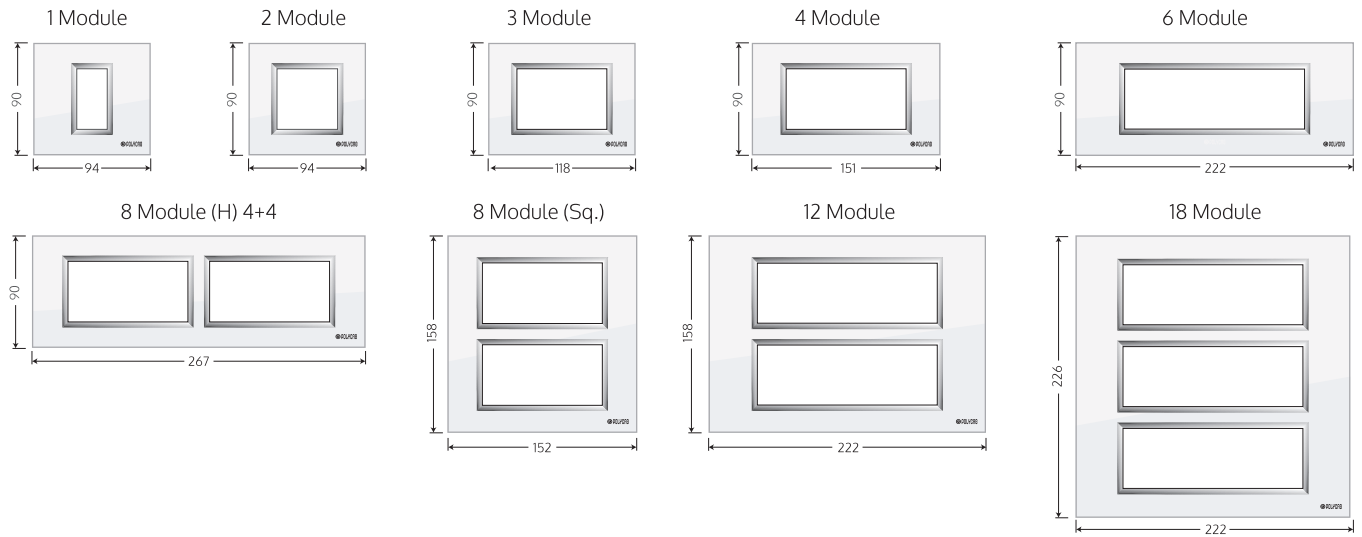

## CAPRINA SERIES

## COVER PLATES WITH MOUNTING PLATES (Available Sizes, DIMENSION IN mm)

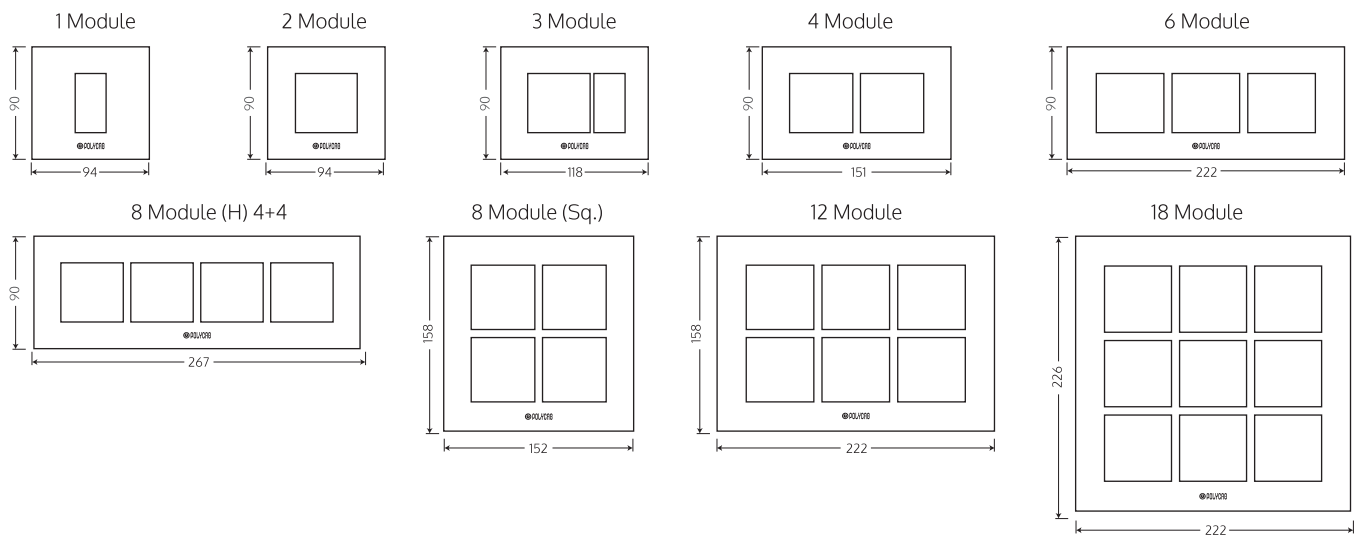

## SUPPORT FRAMES HORIZONTAL & VERTICAL FOR FIXING (DIMENSION IN mm)

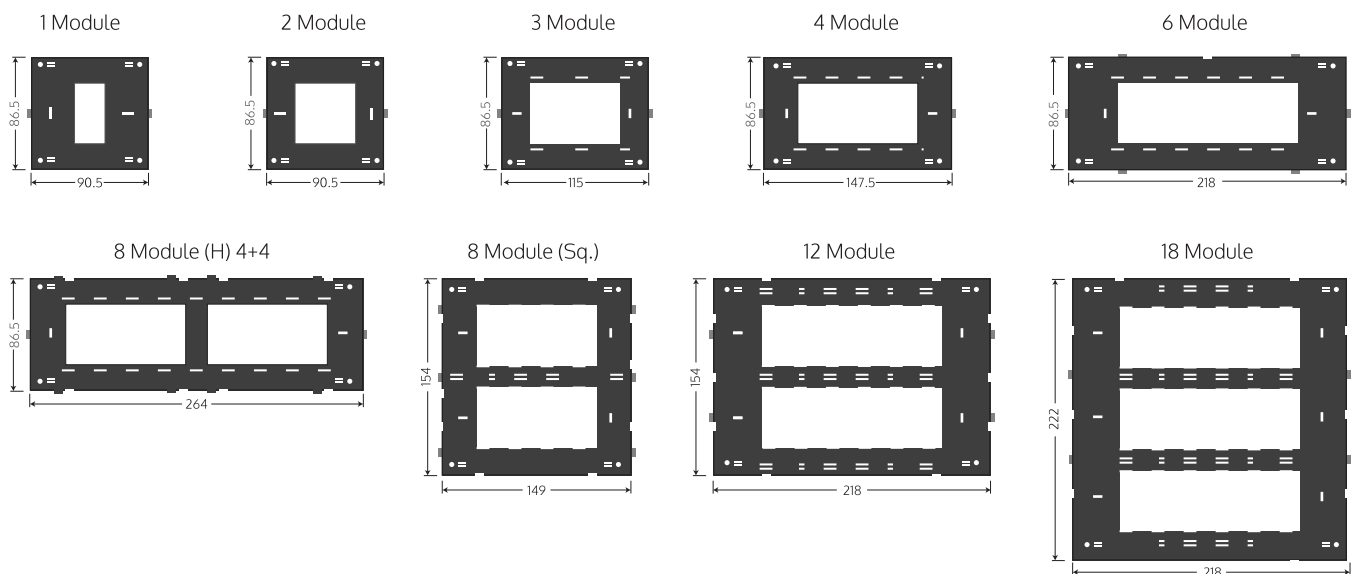

# CONCEALED AND SURFACE BOX

# LEVANA

Code Item Description Cat. No. MRP/Unit ₹ Pkg.

## CONCEALED METAL BOX

SMB0100073	1&2M Concealed Metal Box		64/-	10 / 150
SMB0100074	3M Concealed Metal Box		90/-	10 / 100
SMB0100075	4M Concealed Metal Box		108/-	10 / 80
SMB0100076	6M Concealed Metal Box		148/-	10 / 60
SMB0100077	8M Sq. Concealed Metal Box		194/-	5 / 40
SMB0100081	8M Hor. Concealed Metal Box		194/-	5 / 50
SMB0100079	12M Concealed Metal Box		237/-	5 / 30
SMB0100082	16M Concealed Metal Box		260/-	5 / 20
SMB0100080	18M Concealed Metal Box		292/-	5 / 20



### Salient Features :

- High Durability • Corrosion Resistant
- With Earthing Terminal

## CONCEALED PLASTIC BOX

SPB0100065	1&2M Concealed Plastic Box		43/-	10 / 160
SPB0100066	3M Concealed Plastic Box		48/-	10 / 160
SPB0100067	4M Concealed Plastic Box		63/-	10 / 160
SPB0100068	6M Concealed Plastic Box		98/-	10 / 120
SPB0100069	8M Sq. Concealed Plastic Box		124/-	5 / 80
SPB0100070	8M Hor. Concealed Plastic Box		124/-	5 / 80
SPB0100071	12M Concealed Plastic Box		158/-	5 / 60
SPB0100072	18M Concealed Plastic Box		202/-	5 / 60



## SURFACE MOUNTING PLASTIC BOX

SPB0200057	1&2M Surface Mounting Plastic Box		57/-	10 / 160
SPB0200058	3M Surface Mounting Plastic Box		70/-	10 / 160
SPB0200059	4M Surface Mounting Plastic Box		80/-	10 / 160
SPB0200060	6M Surface Mounting Plastic Box		104/-	10 / 120
SPB0200061	8M Sq. Surface Mounting Plastic Box		145/-	5 / 80
SPB0200062	8M Hor. Surface Mounting Plastic Box		145/-	5 / 80
SPB0200063	12M Surface Mounting Plastic Box		186/-	5 / 60
SPB0200064	18M Surface Mounting Plastic Box		242/-	5 / 60



# Experience precision with Innovation Accessories



Code	Item Description	MRP ₹ Per Unit	Pkg.
SAC0200004	16A 3-PIN PLUG ISI	84/-	20
SAC0200003	06A 3-PIN PLUG ISI	55/-	20
SAC0100001	4-WAY EXTENSION BOARD 4 universal-socket outlet + 1 switch / indicator / cord Length 1.5 meter	575/-	10
SAC0100002	4-WAY EXTENSION BOARD 4 universal-socket outlet + 2 USB 500ma 5v with 1 switch / indicator / cord-Length 1.5meter	825/-	10
SLV1900101	ANGLED / BATTEN BULBHOLDER LEVANA	66/-	20
SLV2000301	JUMBO CEILING ROSE 3T LEVANA	42/-	20
SLV2000201	JUMBO CEILING ROSE 2T LEVANA	35/-	20
SLV1700100	Wireless Door Bell with Bluetooth Speaker (Indoor & Outdoor unit)	5150/-	



4-WAY EXTENSION BOARD



3PIN PLUG TOP



ANGLED / BATTEN BULB HOLDER



JUMBO CEILING ROSE

# Notes

A series of horizontal dotted lines for writing notes, extending across the width of the page.

## WARRANTY POLICY

MCB's	36 Months
RCCB's & RCBO's	36 Months
DB's	12 Months
LEVANA Switches & Socket	120 Months
Electronic wiring product (viz Dimmers, Step Fan Regulators, Moter Starters, Indicator, Buzzers RJ45,RJ11 & TV sockets)	24 Months
Automation and Accessories	12 Months

Polycab's Products carry a warranty against manufacturing defects, subject to use of the Product for the right application with correct wiring/connection and normal operating conditions.



Email: [customercare@polycab.com](mailto:customercare@polycab.com)

Toll Free No.: 1800 267 0008

• Working Days: Monday to Saturday • Timings: 9:00 AM to 6:00 PM

Corporate Office:

**POLYCAB WIRES PVT. LTD.**

Polycab House, 771, Mogul Lane, Mahim (W), Mumbai - 400 016, Maharashtra (India) Ph.: +91-22-2432 7070/4, 6735 1400,  
Fax: +91-22-24327075, Email: enquiry@polycab.com • www.polycab.com

**Regional & Branch Offices:**

**NORTH REGIONAL OFFICE :**

CHANDIGARH : SCO-10-11-12, SEC 17 B, Chandigarh - 160017. • LUCKNOW : Shalimar Square, Office No - 09, 126/31, B. N. Road, Lalbagh, Hazratganj, Lucknow - 226001. • NOIDA : B9, 1<sup>st</sup> Floor Sector - 3, Near Bajaj Bhawan, Noida - 201301. • DEHRADUN : 109, Tagore Villa, Near P. N. B., Dehradun - 248001.  
• JAIPUR : B-44 & B-45, Industrial Area, Sudarshanpura Extn., Bais Godam, Jaipur - 302019.

**EAST REGIONAL OFFICE :**

GUWAHATI : 3<sup>rd</sup> Floor, Purbi Complex, Near Panbazar Flyover, A. T. Road, Guwahati - 781001. • KOLKATA : 18, Rabindra Sarani, Poddar Court, Gate No. 3, 5<sup>th</sup> Floor, Kolkata - 700001. • ORISSA : A/2, RCC Building, Ground Floor, Saheed Nagar, Bhubaneswar, Orissa - 751007. • PATNA : D-302, Dumraon Palace, 3<sup>rd</sup> Floor, Fraser Road, Near Dakbangla Crossing, Patna - 800001. • RANCHI : Polycab Wires Pvt Ltd Gr. Floor, Panchwati Tower, Harmu Bypass, Near Ratu Road Chowk Behind Vishal Management Ranchi: 834002 (Jharkhand)

**WEST REGIONAL OFFICE :**

AHMEDABAD : 102-1<sup>st</sup> Floor, Hrishikesh, Opp. Gulbai Tekra Water Tank, Nr. IDBI Bank Cross Road, Ahmedabad - 380006. • INDORE : B-12, New Siyaganj, Patthar Godam Road, Indore - 452003. • PUNE : Off No. 36, Sangam Project Phase 2, Near RTO Pune, Near Sangam Bridge, Pune - 411001. • RAIPUR : 506, 5<sup>th</sup> Floor, Wallfort Ozone, Near Fafadih Chowk, Raipur (C.G.) 492001.

**SOUTH REGIONAL OFFICE :**

BENGALURU : B-78, No.18, 4<sup>th</sup> Main Road, KSSIDC Industrial Estate, 6<sup>th</sup> Block, Rajajinagar, Bangalore - 560010. • CHENNAI : Polycab wires pvt.ltd Rain Tree Place New.no.7, Old No.9 2b, second Floor Mc Nichols Road, chetpet Chennai - 600031 • KOCHI : 34/138 C, NH By-Pass Road, Edappally, Kochi - 682024.  
• SECUNDERABAD : 208-209, 2<sup>nd</sup> Floor Bhuvana Towers S. D. Road, Secunderabad - 500 003. • VIJAYAWADA : Ground Floor, House No. 40-5/7-6, Municipal Employees Colony, Vijayawada - 520010 (AP). • COIMBATORE : No: 45, K. K. Lane, No. 3, Near Avinashi Road Flyover, Coimbatore - 641 018.



**Terms and Conditions:**

The prices are inclusive of all Government levies. • Goods are despatched by us on purchaser's risk. • All claims for loss, damage or shortage will be filed by the purchaser directly with carriers. • Disputes, if any are subject to Mumbai jurisdiction only. • Price are subject to change without notice. • MRP mentioned is for per unit & in Indian Rupees • Due to continuous technology upgrades the design & specifications may vary without notice.

Follow us on:



[www.facebook.com/PolycabInd](http://www.facebook.com/PolycabInd)



[www.twitter.com/PolycabIndia](http://www.twitter.com/PolycabIndia)



[www.linkedin.com/company/PolycabIndia](http://www.linkedin.com/company/PolycabIndia)



CONTACT (Toll Free No.) 1800 267 0008